













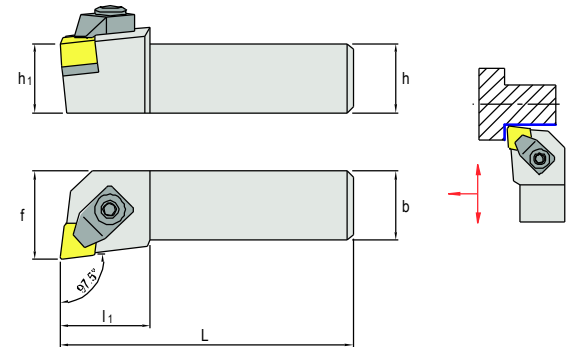
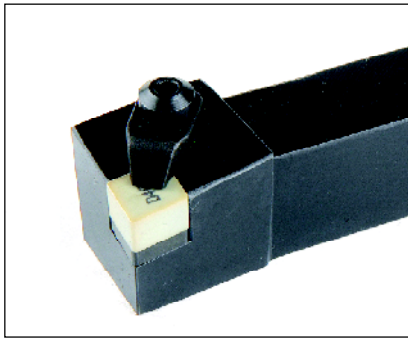

Kod Code Bezeichnung	Ölçüler Dimensions Abmessungen											
	h	b	L	l ₁	f	Uç Tipi Insert Type Plattentype	İnce Altlık Anvil Thin Unter. Dünne	Uç Tipi Insert Type Plattentype	Kalın Altlık Anvil Thick Unterlage Dicke	Altlık Vidası Anvil Screw Gewindehülse	Baskı Pabucu Clamp Klemme	Baskı Vidası Clamp Screw Klemmschraube
CCLNR/L 20 20 K12S	20	20	125	30	25	CNG....1208...	SRD 12 ALT	CNG....1204...	SRD 12 AL2	M4 x 12 AV	70.91.11.134.0	70.91.11.BV
25 25 M12S	25	25	150	30	32							
32 25 P12S	32	25	170	30	32							



Kod Code Bezeichnung	Ölçüler Dimensions Abmessungen											
	h	b	L	l ₁	f	Uç Tipi Insert Type Plattentype	İnce Altlık Anvil Thin Unter. Dünne	Uç Tipi Insert Type Plattentype	Kalın Altlık Anvil Thick Unterlage Dicke	Altlık Vidası Anvil Screw Gewindehülse	Baskı Pabucu Clamp Klemme	Baskı Vidası Clamp Screw Klemmschraube
CELNR/L 20 20 K13S	20	20	125	32	25	ENG....1308...	SE 12 ALT	ENG....1308..	SE 12 AL2	M4 x 12 AV	70.91.11.134.0	70.91.11.BV
25 25 M13S	25	25	150	32	32							
32 25 P13S	32	25	170	32	32							